

Features

- Unique vertical holder makes changing toilet paper quick and simple
- Coordinates with other products in the Artifacts collection

Material

- Premium metal construction for durability and reliability
- KOHLER finishes resist corrosion and tarnishing

Installation

- Installation template and tools included

Included Components

Additional Components:
Installation hardware



Codes/Standards







None Applicable

KOHLER® Faucet Lifetime Limited Warranty

See website for detailed warranty information.

Available Colors/Finishes

Color tiles intended for reference only.

| Color | Code | Description |
|---|------|--------------------------------|
|  | CP | Polished Chrome |
|  | SN | Vibrant™ Polished Nickel |
|  | BN | Vibrant™ Brushed Nickel |
|  | BV | Vibrant™ Brushed Bronze |
|  | 2BZ | Oil-Rubbed Bronze |
|  | 2MB | Vibrant™ Brushed Moderne Brass |

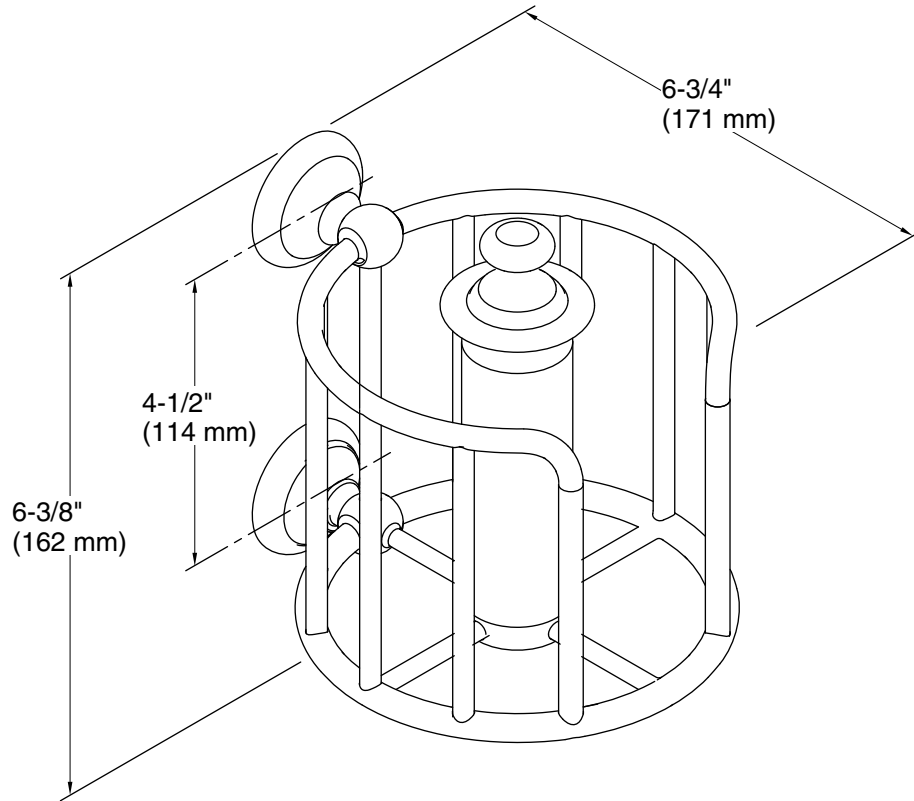

Technical Information

All product dimensions are nominal.

Material: Metal

Notes

Install this product according to the installation guide.

CAUTION: Risk of personal injury. Do not install these products in any area where they are likely to be used inadvertently as a grab bar or support bar. These products are not designed or intended for use as a grab bar or support bar.